

ROBERTS

Revival

DAB/DAB+/FM RDS digital radio
model RD-60



DAB
Digital Audio Broadcasting

DAB+

+ Digital
Radio

Please read this manual before use

Contents

<i>Controls</i>	2-3	<i>Software version</i>	19
<i>Battery operation</i>	4	<i>Software upgrades</i>	19
<i>Using the AC adaptor</i>	4	<i>Language function</i>	20
<i>Operating your radio - DAB</i>	5	<i>System reset</i>	21
<i>Selecting a station - DAB</i>	6	<i>Headphone socket</i>	22
<i>Display options - DAB</i>	7	<i>Auxiliary input socket</i>	22
<i>Finding new stations - DAB</i>	8	<i>Line output socket</i>	23
<i>Secondary services - DAB</i>	8	<i>Display backlight</i>	23
<i>Manual tuning - DAB</i>	9	<i>General</i>	24
<i>Signal strength display - DAB</i>	9	<i>Specifications</i>	25
<i>Dynamic range control (DRC) settings - DAB</i>	10	<i>Circuit features</i>	25
<i>Prune stations - DAB</i>	11	<i>Guarantee</i>	26
<i>Operating your radio - Search tuning FM</i>	12		
<i>Manual tuning - FM</i>	13		
<i>Display options - FM</i>	14		
<i>Scan sensitivity - FM</i>	15		
<i>Favourite button</i>	16		
<i>Recalling your favourite station</i>	16		
<i>Preset stations DAB and FM</i>	17		
<i>FM stereo/mono (headphones only)</i>	18		

Controls

(Top)

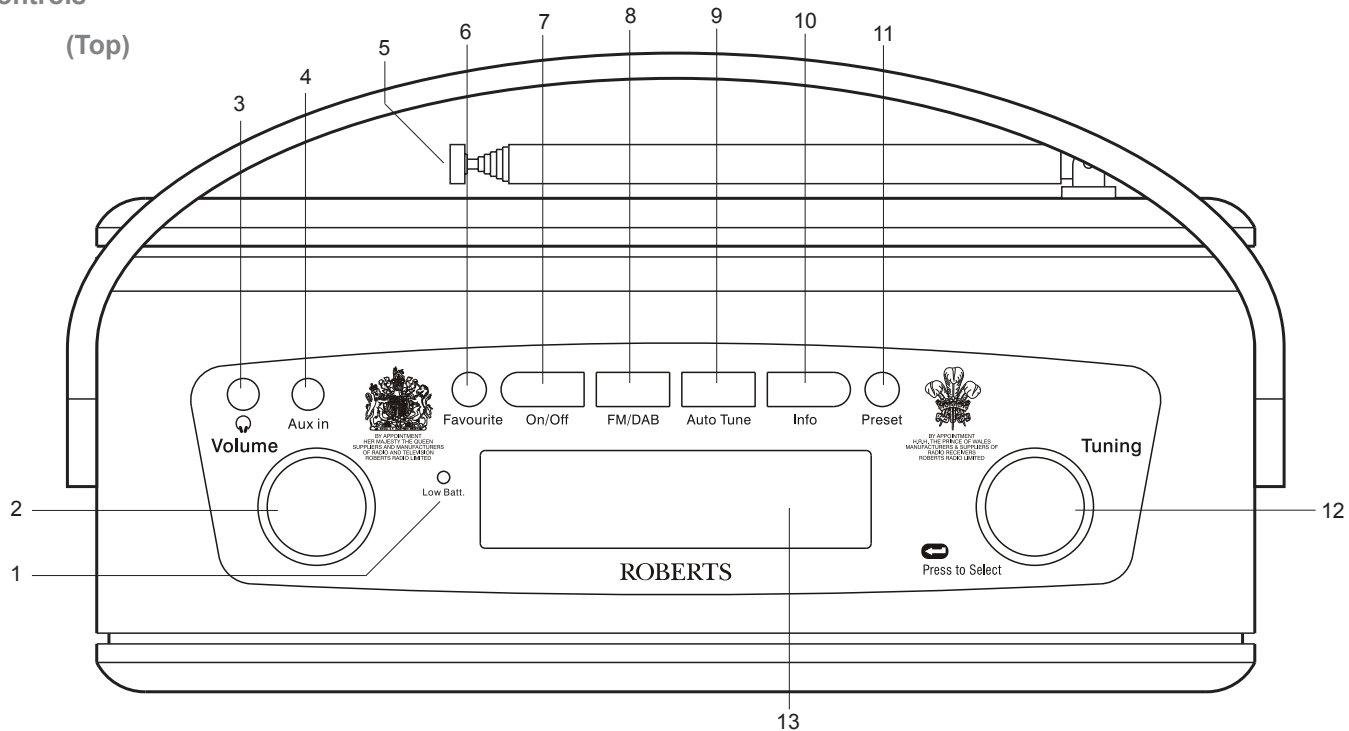

- 1. Low battery indicator
- 2. Volume control
- 3. Headphone socket
- 4. Auxiliary Input socket
- 5. Telescopic aerial

- 6. Favourite button
- 7. On/Off button
- 8. FM/DAB button
- 9. Auto Tune button
- 10. Info button

- 11. Preset button
- 12. Tuning / Select control
- 13. LCD display

Controls

(Rear)

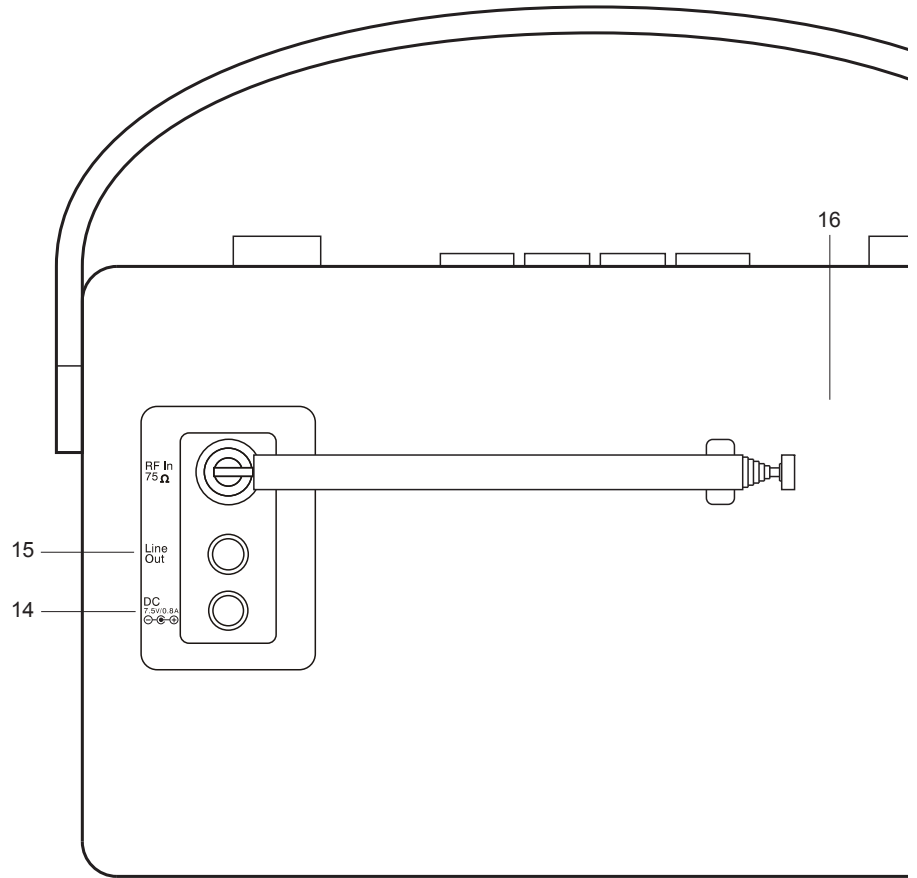

14. DC in socket

15. Line output socket

16. USB socket located inside (for service use only)

Battery operation

1. Release the catch securing the rear door of your radio.
2. Insert four LR20 (D size) batteries into the spaces in the compartment. Take care to ensure all batteries are inserted with the correct polarity as shown inside the battery compartment. Close the rear door and secure the catch.
3. The Low Battery indicator lighting, distortion, or the radio switching itself off are all signs that the batteries may need replacing.
4. If the radio is not to be used for any extended period of time it is recommended that the batteries are removed from the radio.

We would recommend for economy that the RD-60 is used via the AC adaptor whenever possible with battery operation for occasional or stand-by use only.

IMPORTANT: The batteries should not be exposed to excessive heat such as sunshine, fire or the like. After use, disposable batteries should if possible be taken to a suitable recycling centre. On no account should batteries be disposed of by incineration.

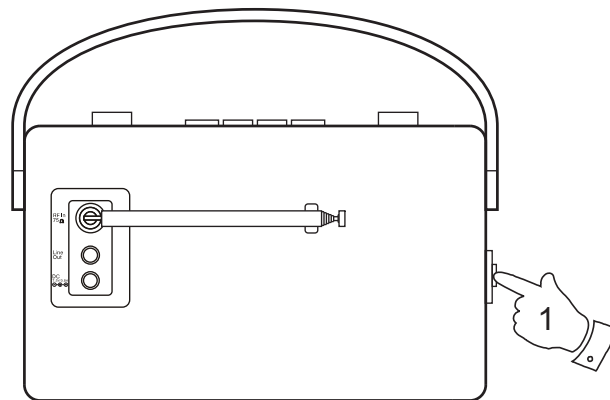

Using the AC adaptor

1. Insert the adaptor plug into the DC in socket on the rear of your radio.
2. Plug the adaptor into a standard mains socket outlet. Whenever the adaptor is used the batteries are automatically disconnected.

The AC adaptor should be disconnected from the mains supply and the radio when not in use.

- **IMPORTANT:** The mains adaptor is used as the means of connecting the radio to the mains supply. The mains socket used for the radio must remain accessible during normal use. In order to disconnect the radio from the mains completely, the mains adaptor should be removed from the mains socket outlet completely.

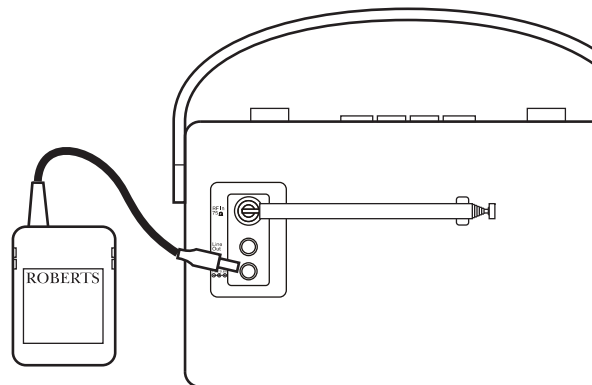

Operating your radio - DAB

1. Carefully extend the telescopic aerial fully.
2. Press and release the **On/Off** button to switch on your radio. The display will show *Welcome to DAB*. When first switched on, the radio will be in DAB mode. After each use the radio will remember the mode used and then switch on in that mode the next time that it is used.
3. If this is the first time the radio is used a scan of the Band III DAB channels will be carried out. If the radio has been used before the last used station will be selected.
4. During the scanning process, the lower line of the display shows a bar-graph indicating progress of the scan.
5. When the scanning is completed the first station (in numeric-alpha order 0...9...A...Z) will be selected. The first station in the list of stations found during scanning will be played. The display will show the station name.
6. If the station list is still empty after the scan your radio will display *'Service not available'*.
7. If no signals are found it may be necessary to relocate your radio to a position giving better reception. Then, either switch your radio off and on again, or press and release the **Auto Tune** button to repeat the scan.

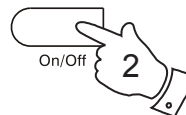

```
Welcome to DAB
■■■■■■■■■■
```

```
BBC R2      DAB
Now tuning...
```

```
BBC R2      DAB
Im sorry I have
```

```
Classic     DAB
Service not avai
```

Selecting a station - DAB

1. The top line of the display shows the name of the station currently selected.
2. Press and release the **FM/DAB** button until the DAB mode is selected.
3. Rotate the **Tuning** control to scroll through the list of available stations on the lower line of the display. Stop rotating the Tuning control when you find the station that you wish to hear.
4. Press and release the **Tuning** control to select the station. The display may show 'Now tuning...' while your radio finds the new station.
5. Adjust the **Volume** control to the required setting.

Note: If after selecting a station the display shows 'Service not available' it may be necessary to relocate your radio to a position giving better reception.

The use of radio station presets for selecting your preferred radio stations is described on page 17.

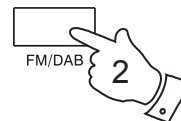

Classic DAB
Classical Music

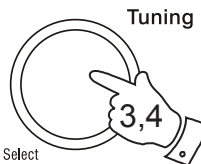

 Press to Select

Classic DAB
+BBC R2 +

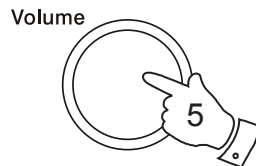

BBC R2 DAB
Now tuning...

Display options - DAB

Your radio has a range of display options in DAB mode.

1. Press and release the **Info** button to cycle through the various options.

- a. Scrolling text Displays scrolling text messages such as artist/track name, phone in number etc.
- b. Program Type Displays the type of station being listened to e.g. Pop, Classic, News etc.
- c. Multiplex Name Displays the name of DAB multiplex to which the current station belongs.
- d. Time and date Displays the current time and date.
- e. Frequency Displays the frequency of the DAB multiplex for the station listened to.
- f. Bit rate & audio type Displays the digital bit rate & audio type for the station being listened to.
- g. Signal Strength Displays a graph showing the signal strength for the station being received. The clear unfilled rectangle indicates the minimum signal level required for satisfactory DAB reception.

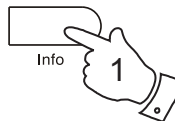

a BBC R2 DAB
Im sorry I have

b BBC R2 DAB
Varied Speech

c BBC R2 DAB
BBC National DAB

d BBC R2 DAB
19:17 08-06-2014

e BBC R2 DAB
12B 225.648MHz

f BBC R2 DAB
80kbps / MP2

g BBC R2 DAB
■■■■■ □ ■■■■

Finding new radio stations - DAB

As time passes new stations may become available. To find new stations proceed as follows:-

1. Press and release the **Auto Tune** button. The display will show 'Scanning...' and your radio will perform a scan of the Band III DAB channels. As new radio stations are found the station counter on the right-hand side of the display will increase and the radio stations will be added to the list stored in the radio.

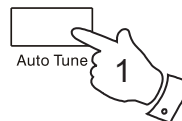

Secondary services - DAB

1. Certain radio stations have one or more secondary services associated with them. If a radio station has a secondary service associated with it the display will show '>>' next to the station name on the station list. The secondary service will then appear immediately after the primary service as you rotate the tuning control clockwise.
2. Press and release the **Tuning** control to select the station.
3. When the secondary service shuts down, your radio will automatically switch back to the main radio station (or primary service) if it is available.

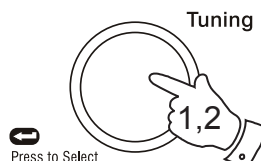

Manual tuning - DAB

Manual tuning allows you to tune directly to the various DAB Band III channels. UK DAB stations located in the range 11B to 12D.

1. Press and hold the **Info** button until the display shows 'Manual tune'. Press and release the **Tuning** control to select this function.
2. Rotate the **Tuning** control to select the required DAB channel.
3. Press and release the **Tuning** control to select the desired channel. The graph will indicate the signal strength, and the lower line will show the name of the DAB Multiplex (group of radio stations). Any stations found will be added to the stored list in the radio.
4. Press and release the **Tuning** control to return to the normal tuning mode.

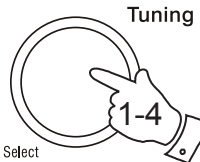
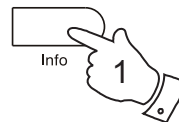

DAB
◆Manual tune◆

Manual tune
◆5A 174.928MHz◆

■■■■■
11D 222.064MHz

Classic DAB
Now tuning...

Signal strength display - DAB

1. Repeatedly press and release the **Info** button until the lower line of the display shows signal strength.
2. Position your radio and try moving the aerial so as to give maximum number of black rectangles on signal strength display. Normally, the best reception will be found with the aerial vertical and fully extended.
3. The clear unfilled rectangle indicates minimum signal level required for satisfactory reception.

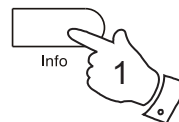

BBC R2 DAB
■■■■■

Dynamic Range Control settings - DAB

Dynamic Range Control (also known as DRC) can make quieter sounds easier to hear when your radio is used in a noisy environment.

1. Press and release the **On/Off** button to switch on your radio.
2. Press and release the **FM/DAB** button until the DAB mode is selected.
3. Press and hold the **Info** button.
4. Rotate the **Tuning** control until the display shows 'DRC'.
5. Press and release the **Tuning** control to enter the adjustment mode.
6. Rotate the **Tuning** control to select the required DRC setting (the default is 0).

DRC 0 - DRC is switched off, Broadcast DRC will be ignored.

DRC 1/2 - DRC level is set to 1/2 that sent by broadcaster.

DRC 1 - DRC level is used as sent by broadcaster.

7. Press and release the **Tuning** control to confirm the setting. The display will return to normal tuning mode.

Note: Not all DAB broadcasts are able to use the DRC function. If the broadcast does not support DRC, then the DRC setting in the radio will have no effect.

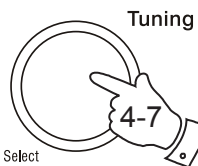
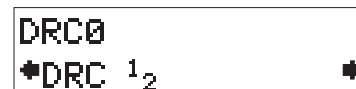
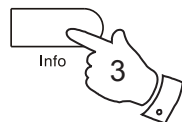
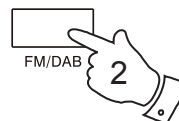
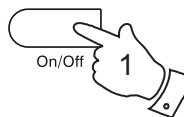

Prune stations - DAB

Over time, some DAB services may stop broadcasting, or may change location and then not be able to receive a station. In order to remove such stations from the DAB station list, the Prune stations function will delete the DAB stations from your station list that can no longer be received.

Stations which cannot be found or which have not been received for a very long time are shown in the station list with a question mark.

1. Press and release the **On/Off** button to switch on your radio.
2. Press and release the **FM/DAB** button until the DAB mode is selected.
3. Press and hold the **Info** button.
4. Rotate the **Tuning** control until 'Prune' appears on the display. Press and release the **Tuning** control.
5. Rotate the **Tuning** control to select 'Yes'. Press and release the **Tuning** control to cause the stations list to be pruned, eliminating unavailable stations.
6. If you do not wish to prune stations select 'No' in step 5 and then press and release the **Tuning** control. The display will revert back to the previous display.

Note: If you have moved to a different part of the country you should also carry out a search for new stations (please see the section 'Finding new stations' on page 8).

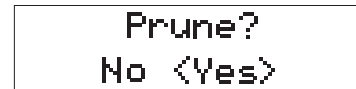
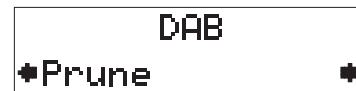
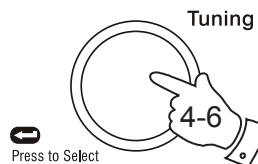
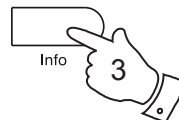
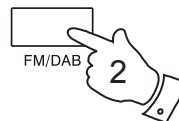
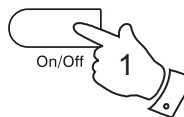

Operating your radio - Search tuning FM

1. Carefully extend the telescopic aerial fully.
2. Press and release the **On/Off** button to switch on your radio.
3. Press and release the **FM/DAB** button until the FM mode is selected.
4. Press and immediately release the **Auto tune** button, your radio will scan in an upwards direction (low frequency to high frequency) and stop automatically when it finds a station of sufficient strength.
5. After a few seconds the display will update. The display will show the frequency of the signal found. If the signal is strong enough and there is RDS data present then the radio may display the station name.
6. To find other stations, press and release the **Auto tune** button as before.
7. To scan the FM band in a downwards direction (high frequency to low frequency) press and hold down the **Auto tune** button for 2 seconds and then release.
8. When the waveband end is reached your radio will recommence tuning from the opposite waveband end.
9. Adjust the **Volume** control to the required setting.

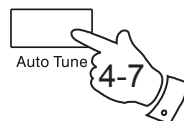
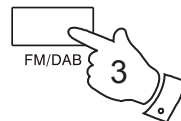
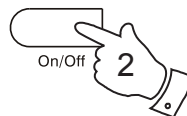

Volume

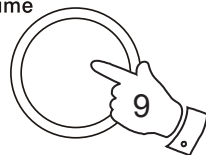

The use of radio station presets for selecting your preferred radio stations is described on page 17.

Manual tuning - FM

1. Press and release the **On/Off** button to switch on your radio.
2. Press and release the **FM/DAB** button until the FM mode is selected. Carefully extend the telescopic aerial fully for FM reception.
3. Rotate the **Tuning** control to tune to a station. With each click of the control the frequency will change up or down by 50 kHz.
4. When the waveband end is reached the radio will recommence tuning from the opposite waveband end.
5. Set the **Volume** control to the desired settings.
6. To switch off your radio press and release the **On/Off** button.

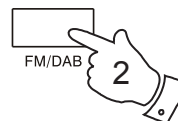
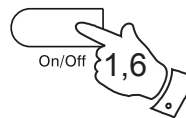

Tuning

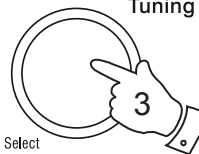

Press to Select

Volume

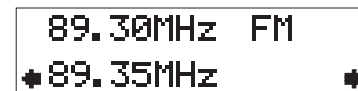
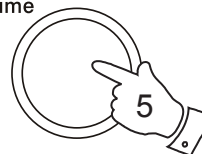

Display options - FM

Your radio has a range of display options in FM mode.

The Radio Data System (RDS) is a system in which inaudible digital information is transmitted in addition to the normal FM radio programme. RDS offers several useful features. The following are available on your radio.

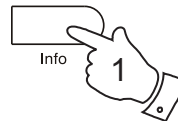

1. Press and release the **Info** button to cycle through each of the options.

- | | |
|-------------------|--|
| a. Scrolling text | Displays scrolling text messages such as artist/track name, phone in number etc. |
| b. Program type | Displays type of station being listened to e.g. Pop, Classic, News, etc. |
| c. Time and date | Displays the current time and date. |
| d. Frequency | Displays frequency of the station being listened to. |
| e. Audio mode | Display shows Auto (stereo) or Mono. |

Note: Your radio will display "NO Radio Text" on the lower line of the display if there is no scrolling text available and "NO PTY" if there is no programme type information.

a

BBC R2	FM
The latest news	

b

BBC R2	FM
Pop Music	

c

BBC R2	FM
19:17 08-06-2014	

d

BBC R2	FM
89.30MHz	

e

BBC R2	FM
Auto (Stereo)	

Scan sensitivity setting - FM

Your radio will normally scan for FM broadcasts which are strong enough to give good reception. However, you may wish the Auto-scan function to also be able to find weaker signals, possibly from more distant radio transmitters. Your radio includes a local / distant option for the Auto-scan function.

1. Press and release the **On/Off** button to switch on your radio.
2. If needed, press and release the **FM/DAB** button to select the FM mode.
3. Press and hold the **Info** button to enter the FM menu.
4. Rotate the **Tuning** control until the display shows 'FM Scan Zone' then press and release the **Tuning** control to enter the scan zone selection menu.
5. Rotate the **Tuning** control to switch between Local and Distant options on the lower line of the display. The Distant option will allow the radio to find weaker signals when scanning.
6. Press and release the **Tuning** control to confirm your selection. The radio will then revert to the normal information display. The Local or Distant setting is stored in the radio and remains in force until changed or until a System Reset.

Note: The initial setting (out of the box, or after a System Reset) causes the radio to ignore weaker (or more distant) signals.

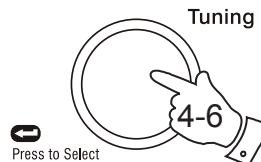
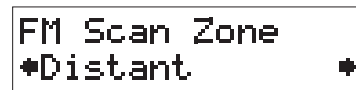
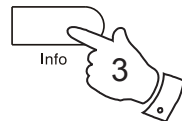
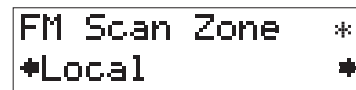
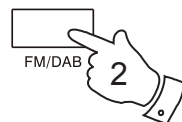
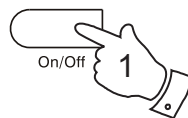

Favourite button

Your radio is fitted with a button which when pressed will automatically select the required waveband and tune to your Favourite radio station. With this button you can store one favourite station from either the DAB or FM wavebands.

To set up your favourite station, follow these steps:

1. Carefully extend the telescopic aerial and switch on your radio.
2. Select the desired waveband (DAB or FM) and tune into the required radio station as described on the preceding pages.
3. Press and hold down the **Favourite** button (for 5 seconds) until the display shows 'My Fav. Saved'.



BBC R2 DAB
My Fav. Saved

Recalling your favourite station

1. Carefully extend the telescopic aerial and switch on your radio.

If your radio is in Auxiliary Input mode, press and release the **FM/DAB** button to select normal radio operation.

2. Momentarily press the **Favourite** button, your radio will automatically select the DAB or FM waveband as needed and then tune to the radio station stored in the favourite memory.



BBC R2 DAB
Im sorry I have

Preset stations - DAB and FM

To make it easier for you to tune your radio to the stations that you prefer, you may store selected radio stations as presets. Your radio holds presets separately for DAB and FM radio modes.

You may set as many or as few presets as you like in each mode.

You can easily switch between displaying all DAB stations (or all FM frequencies) and displaying only those that you have set as presets.

Any station or frequency which has been marked as a preset can easily have the mark cancelled should your preferences or needs change.

Presets are retained when your radio is switched off.

1. To setup your preset stations, tune into the required station.
2. Press and hold down the **Preset** button until the displays shows a tick symbol next to the radio station name or frequency. This indicates that the radio station is marked as a preset. To cancel the preset mark, press and hold the **Preset** button again.
3. Repeat steps 1 and 2 as needed for any other stations that you want as presets.
4. To view only the preset stations for the currently selected waveband when tuning, press and release the **Preset** button so that the heart symbol shows in the display.
5. To listen to one of the preset radio stations, rotate the **Tuning** control until the required radio station is displayed. Press and release the **Tuning** control to select and tune to that station.
6. To cancel the preset stations view, press and release the **Preset** button so that the heart symbol disappears from the display. Your radio will then be able to access the full station list using the **Tuning** control.

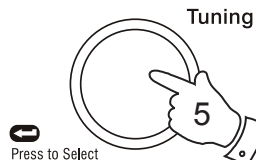
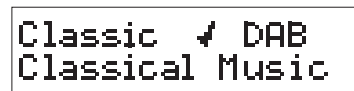

FM Stereo/Mono (Headphones only)

1. If an FM station being received is weak some hiss may be audible. To reduce this, press and release the **Tuning** control so that the display shows 'Switch to Mono'. Your radio will switch to mono mode.
2. To return to stereo mode press and release the **Tuning** control so that the display shows 'Switch to Auto'. Your radio will switch to stereo mode.

Note: Stereo listening is only available when listening via headphones or when using the Line Out socket connected to an external amplifier.

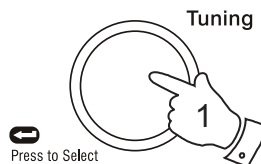

89.30MHz FM
Switch to Mono

89.30MHz FM
Switch to Auto

Software version

The software display cannot be altered and is just for your reference.

1. To view the software version on the display, ensure your radio is in DAB mode and press and hold the **Info** button for 2 seconds.
2. Rotate the **Tuning** control until the display shows 'SW version'. Press the **Tuning** control the software version will appear on the display.
3. Press the **Info** button to revert to the normal display mode.

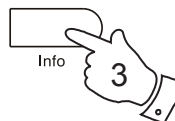
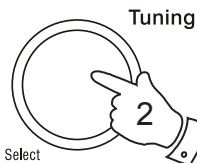
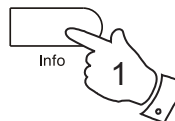

Software upgrades

In the event that any software update is made available for your radio, information on how to update your radio will be made available via our website at <http://www.robertsradio.com>

Language function

Your radio can be configured to a different language.

1. Press and release the **On/Off** button to switch on your radio.
2. Press and release the **FM/DAB** button until the DAB mode is selected.
3. Press and hold the **Info** button to enter the DAB menu.
4. Rotate the **Tuning** control until the display shows 'Language'.
5. Press and release the **Tuning** control to enter the language adjustment mode. The current setting will be marked with an asterisk.
6. Rotate the **Tuning** control until your desired language appears on the display.
7. Press and release the **Tuning** control to confirm your choice. The display will change to the chosen language.

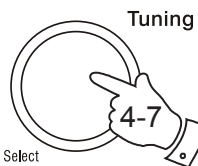
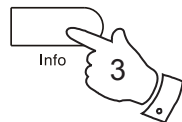
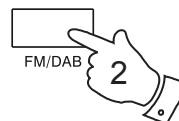
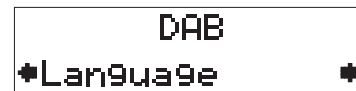
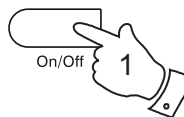

System reset

If your radio fails to operate correctly, or some digits on the display are missing or incomplete, it may be possible to restore normal operation by carrying out a System Reset operation on your radio. This will restore the radio's settings to their factory defaults. No presets will be stored, and the list of DAB radio stations will be empty.

If you have moved to a different part of the country and you wish to erase local DAB radio stations that are no longer available from the stored list, then you may carry out this procedure. Your radio will automatically re-scan for the DAB stations available at your current location when it restarts.

1. Press and release the **On/Off** button to switch on your radio and ensure your radio is in the DAB or FM mode.
2. Press and hold down the **Info** button for 2 seconds.
3. Rotate the **Tuning** control until the display shows 'Factory Reset', then press and release the **Tuning** control.
4. If you wish to perform the reset operation, press and release the **Tuning** control **one more time**. A full reset of your radio will be performed. All presets and station lists will be erased.
5. After a system reset a scan of the DAB band will be performed.

In case of malfunction due to electrostatic discharge, reset the product (temporary disconnection of the power adaptor or removal of batteries may be required) to resume normal operation.

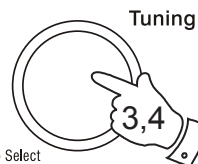
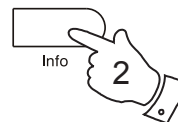

 Press to Select

DAB
Factory Reset

Press SELECT to
confirm reset...

Welcome to DAB
■■■■■■■■

Headphone socket

A 3.5mm **Headphone** Socket located on the top left hand corner of your radio is provided for use with either headphones or an earpiece. Inserting a plug automatically mutes the internal loudspeaker.

Please be aware that the sensitivity of headphones can vary widely. We therefore recommend setting the volume to a low level before connecting headphones to the radio.

IMPORTANT: Excessive sound pressure from earphones and headphones can cause hearing loss.



To prevent possible hearing damage, do not listen at high volume levels for long periods.

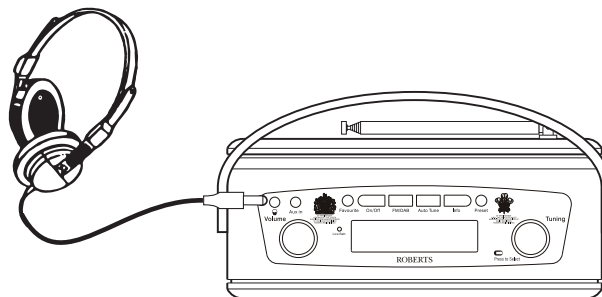

Auxiliary input socket

1. Connect a stereo or mono audio source (i.e. CD player, MP3 player, etc.) to the **Auxiliary input** socket.
2. Press and release the **On/Off** button to switch on the radio. Press and release the **FM/DAB** button until the display shows 'AUX IN'.

Note: that the Auxiliary Input mode can only be selected when a plug is inserted in the socket.

3. Adjust the **Volume** control on your player and on the radio for comfortable listening.
4. Remove the cable from the **Auxiliary input** socket or press and release the **FM/DAB** button to cancel Auxiliary Input mode.

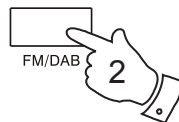
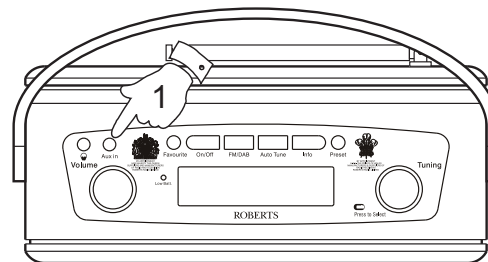

Line out socket

A 3.5mm stereo **Line out socket** located on the rear of your radio is provided for connecting the audio signal to an external amplifier. Inserting a line out audio cable will not mute the internal loudspeaker. Set the volume control on the radio to minimum if desired.

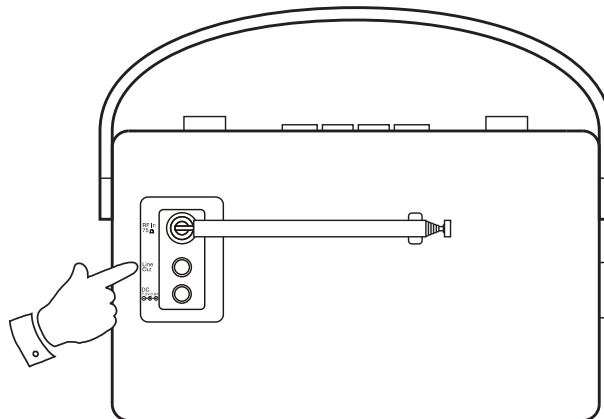

Display backlight

1. When using the radio powered from batteries, the display backlight will be switched on for approximately 12 seconds when any button is pressed.
2. When your radio is powered by the AC mains using the supplied mains adaptor the display backlight will always be on whenever the radio is switched on.

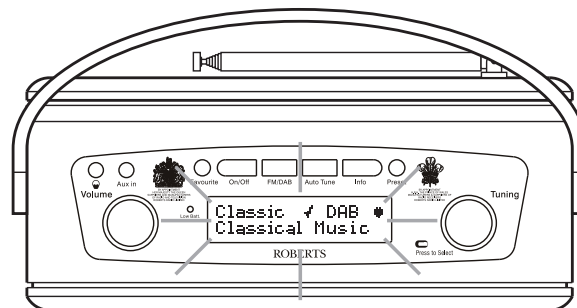

General

Do not allow this radio to be exposed to water, steam or sand. Do not leave your radio where excessive heat could cause damage such as in a parked car where the heat from the sun can build up even though the outside temperature may not seem too high. It is recommended that the DAB band be used wherever possible as better results in terms of quality and freedom from interference will usually be obtained than on the FM band.

The name plate is located on the inside of the rear door on your radio.



Please handle with care. The leather-cloth finish may be susceptible to damage if mistreated. Avoid all contact with any abrasive material, chemical substances or cleaning solutions. Your radio may be wiped with a clean lightly damp cloth.

Please ensure that the product is unplugged from the mains socket outlet before attempting this procedure.

- Your radio should not be exposed to dripping or splashing and that no objects filled with liquids, such as vases, shall be placed on the radio.
- It is recommended to operate the product such that there is a minimum distance (10cm recommended) to adjacent objects in order to ensure good ventilation.
- The ventilation of the product should not be restricted by covering it or its ventilation openings with items such as newspapers, tablecloths, curtains etc.
- No naked flame sources such as lighted candles should be placed on the product.
- It is recommended to avoid using or storing the product at extremes of temperature. Avoid leaving the unit in cars, on window sills, in direct sunlight etc.
- The product must be used in a moderate climate.

Specifications

Power Requirements

Mains	AC 100 - 240 volts, 50 - 60 Hz  only (adaptor)
Batteries	4 x LR20 (D size)

Battery Life

Approx. 120 hours of listening for 4 hours a day at normal volume using alkaline cells.

Frequency Coverage

FM	87.5-108MHz
DAB	174.928 - 239.200MHz

Circuit Features

Loudspeaker		75mm full range
Output Power		1.0 Watt
Headphone socket		3.5mm dia.
Auxiliary Input socket		3.5mm dia.
Line out socket		3.5mm dia.
Aerial System	FM	Telescopic aerial
	DAB	Telescopic aerial

Guarantee

This product is guaranteed for twenty four months from the date of purchase by the original owner against failure due to faulty workmanship or component breakdown, subject to the procedure stated below. Should any component or part fail during this guarantee period it will be repaired or replaced free of charge.

The guarantee does not cover:

1. Damage resulting from incorrect use.
2. Consequential damage.
3. Product with removed or defaced serial numbers.

N.B. Damaged or broken telescopic aerials will not be replaced under guarantee.

Procedure:

Any claim under this guarantee should be made through the dealer from whom the product was purchased. It is likely that your Roberts dealer will be able to attend to any defect quickly and efficiently, but should it be necessary the dealer will return the product to the company's service department for attention. In the event that it is not possible to return the product to the Roberts dealer from whom it was purchased, please contact Roberts Radio using the contact details on the www.robertsradio.com website.

For product repairs falling outside the guarantee period, please refer to the "customer care" tab on the www.robertsradio.com website.

These statements do not affect the statutory rights of a consumer.



Issue 4

ROBERTS RADIO LIMITED

PO Box 130
Mexborough
South Yorkshire
S64 8YT

Website: <http://www.robertsradio.com>

© 2016 Roberts Radio Limited

